

# Small Signal MOSFET

## 115 mAmps, 60 Volts

### N-Channel SOT-23

- We declare that the material of product are Halogen Free and compliance with RoHS requirements.
- ESD Protected:1000V

#### MAXIMUM RATINGS

Rating	Symbol	Value	Unit
Drain-Source Voltage	$V_{DSS}$	60	V <sub>dc</sub>
Drain-Gate Voltage ( $R_{GS} = 1.0 \text{ M}\Omega$ )	$V_{DGR}$	60	V <sub>dc</sub>
Drain Current	$I_D$	$\pm 115$	mAdc
– Continuous $T_C = 25^\circ\text{C}$ (Note 1.)	$I_D$	$\pm 75$	
– Pulsed (Note 2.)	$I_{DM}$	$\pm 800$	
Gate-Source Voltage	$V_{GS}$	$\pm 20$	V <sub>dc</sub>
– Non-repetitive ( $t_p \leq 50 \mu\text{s}$ )	$V_{GSM}$	$\pm 40$	V <sub>pk</sub>

#### THERMAL CHARACTERISTICS

Characteristic	Symbol	Max	Unit
Total Device Dissipation FR-5 Board (Note 3.) $T_A = 25^\circ\text{C}$ Derate above $25^\circ\text{C}$	$P_D$	225 1.8	mW mW/ $^\circ\text{C}$
Thermal Resistance, Junction to Ambient	$R_{\theta JA}$	556	$^\circ\text{C}/\text{W}$
Total Device Dissipation Alumina Substrate,(Note 4.) $T_A = 25^\circ\text{C}$ Derate above $25^\circ\text{C}$	$P_D$	300 2.4	mW mW/ $^\circ\text{C}$
Thermal Resistance, Junction to Ambient	$R_{\theta JA}$	417	$^\circ\text{C}/\text{W}$
Junction and Storage Temperature	$T_J, T_{stg}$	-55 to +150	$^\circ\text{C}$

1. The Power Dissipation of the package may result in a lower continuous drain current.
2. Pulse Test: Pulse Width  $\leq 300 \mu\text{s}$ , Duty Cycle  $\leq 2.0\%$ .
3. FR-5 =  $1.0 \times 0.75 \times 0.062$  in.
4. Alumina =  $0.4 \times 0.3 \times 0.025$  in 99.5% alumina.

#### ORDERING INFORMATION

Device	Marking	Shipping
L2N7002LT1G	702	3000 Tape & Reel
L2N7002LT3G	702	10000 Tape & Reel

## L2N7002LT1G

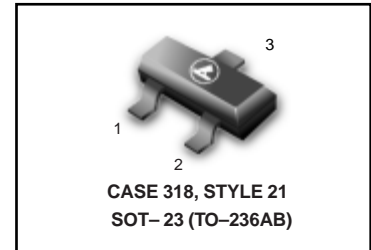

#### Simplified Schematic

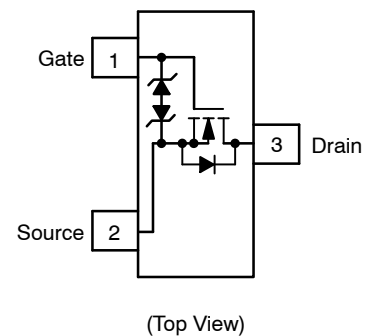

#### MARKING DIAGRAM & PIN ASSIGNMENT

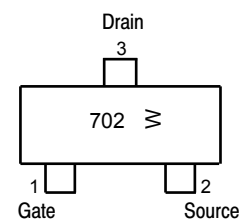

702 = Device Code  
W = Month Code

**L2N7002LT1G**

**ELECTRICAL CHARACTERISTICS** ( $T_A = 25^\circ\text{C}$  unless otherwise noted)

Characteristic	Symbol	Min	Typ	Max	Unit
<b>OFF CHARACTERISTICS</b>					
Drain–Source Breakdown Voltage ( $V_{GS} = 0, I_D = 10 \mu\text{A}$ )	$V_{(BR)DSS}$	60	–	–	Vdc
Zero Gate Voltage Drain Current ( $V_{GS} = 0, V_{DS} = 60 \text{ Vdc}$ )	$I_{DSS}$	– –	– –	1.0 500	$\mu\text{A}$
Gate–Body Leakage Current, Forward ( $V_{GS} = 20 \text{ Vdc}$ )	$I_{GSSF}$	–	–	1	$\mu\text{A}$
Gate–Body Leakage Current, Reverse ( $V_{GS} = -20 \text{ Vdc}$ )	$I_{GSSR}$	–	–	-1	$\mu\text{A}$

**ON CHARACTERISTICS** (Note 2.)

Gate Threshold Voltage ( $V_{DS} = V_{GS}, I_D = 250 \mu\text{A}$ )	$V_{GS(th)}$	1.0	1.6	2	Vdc
On–State Drain Current ( $V_{DS} \geq 2.0 V_{DS(on)}, V_{GS} = 10 \text{ Vdc}$ )	$I_{D(on)}$	500	–	–	mA
Static Drain–Source On–State Voltage ( $V_{GS} = 10 \text{ Vdc}, I_D = 500 \text{ mA}$ ) ( $V_{GS} = 5.0 \text{ Vdc}, I_D = 50 \text{ mA}$ )	$V_{DS(on)}$	– –	– –	3.75 0.375	Vdc
Static Drain–Source On–State Resistance ( $V_{GS} = 10 \text{ V}, I_D = 500 \text{ mA}$ ) $T_C = 25^\circ\text{C}$ $T_C = 125^\circ\text{C}$ ( $V_{GS} = 5.0 \text{ Vdc}, I_D = 50 \text{ mA}$ ) $T_C = 25^\circ\text{C}$ $T_C = 125^\circ\text{C}$	$r_{DS(on)}$	– – –	1.4 – 1.8	7.5 13.5 7.5 13.5	Ohms
Forward Transconductance ( $V_{DS} \geq 2.0 V_{DS(on)}, I_D = 200 \text{ mA}$ )	$g_{FS}$	80	–	–	mmhos

**DYNAMIC CHARACTERISTICS**

Input Capacitance ( $V_{DS} = 25 \text{ Vdc}, V_{GS} = 0, f = 1.0 \text{ MHz}$ )	$C_{iss}$	–	17	50	pF
Output Capacitance ( $V_{DS} = 25 \text{ Vdc}, V_{GS} = 0, f = 1.0 \text{ MHz}$ )	$C_{oss}$	–	10	25	pF
Reverse Transfer Capacitance ( $V_{DS} = 25 \text{ Vdc}, V_{GS} = 0, f = 1.0 \text{ MHz}$ )	$C_{rss}$	–	2.5	5.0	pF

**SWITCHING CHARACTERISTICS** (Note 2.)

Turn–On Delay Time	$(V_{DD} = 25 \text{ Vdc}, I_D \cong 500 \text{ mA}, R_G = 25 \Omega, R_L = 50 \Omega, V_{gen} = 10 \text{ V})$	$t_{d(on)}$	–	7	20	ns
Turn–Off Delay Time		$t_{d(off)}$	–	11	40	ns

**BODY–DRAIN DIODE RATINGS**

Diode Forward On–Voltage ( $I_S = 115 \text{ mA}, V_{GS} = 0 \text{ V}$ )	$V_{SD}$	–	–	-1.5	Vdc
Source Current Continuous (Body Diode)	$I_S$	–	–	-115	mA
Source Current Pulsed	$I_{SM}$	–	–	-800	mA

2. Pulse Test: Pulse Width  $\leq 300 \mu\text{s}$ , Duty Cycle  $\leq 2.0\%$ .

**L2N7002LT1G**

**TYPICAL ELECTRICAL CHARACTERISTICS**

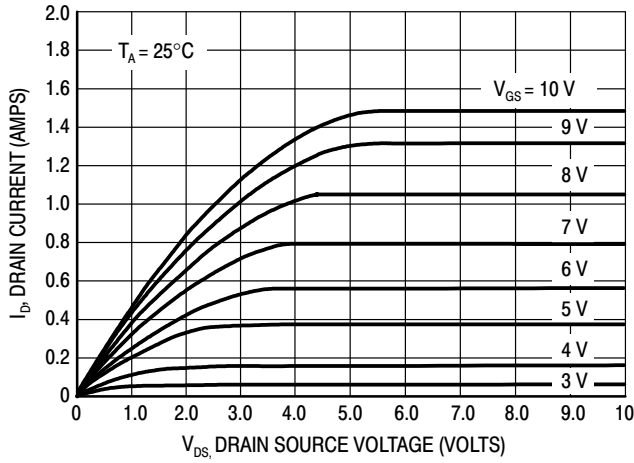

**Figure 1. Ohmic Region**

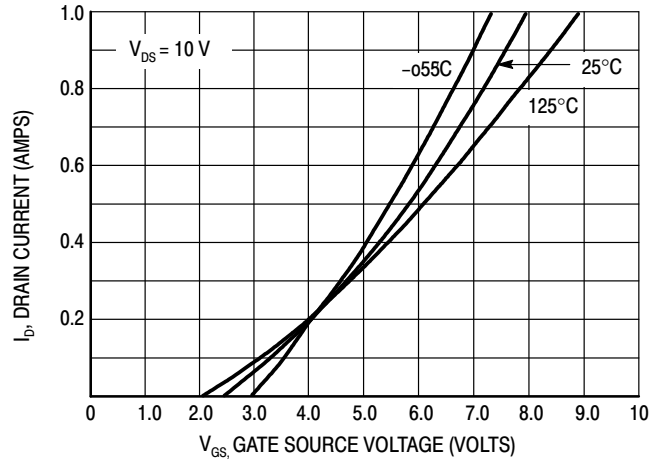

**Figure 2. Transfer Characteristics**

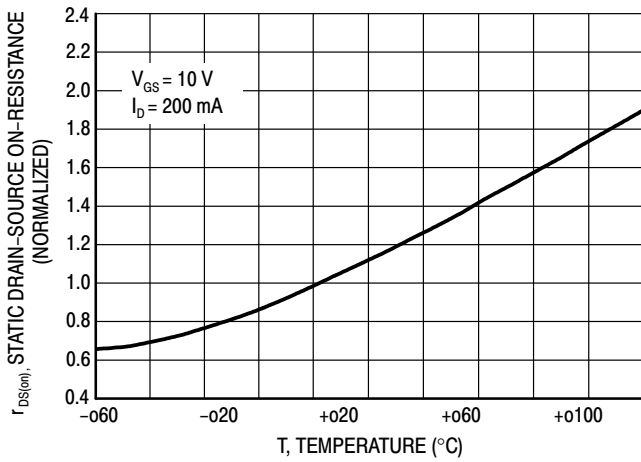

**Figure 3. Temperature versus Static Drain-Source On-Resistance**

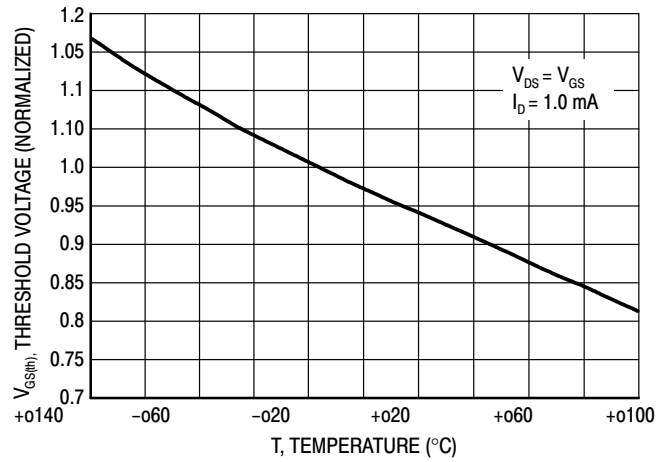

**Figure 4. Temperature versus Gate Threshold Voltage**

**L2N7002LT1G**
**SOT-23**
**NOTES:**

1. DIMENSIONING AND TOLERANCING PER ANSI Y14.5M,1982
2. CONTROLLING DIMENSION: INCH.

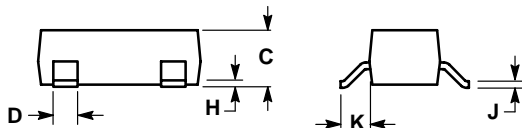
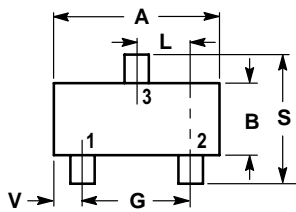

DIM	INCHES		MILLIMETERS	
	MIN	MAX	MIN	MAX
A	0.1102	0.1197	2.80	3.04
B	0.0472	0.0551	1.20	1.40
C	0.0350	0.0440	0.89	1.11
D	0.0150	0.0200	0.37	0.50
G	0.0701	0.0807	1.78	2.04
H	0.0005	0.0040	0.013	0.100
J	0.0034	0.0070	0.085	0.177
K	0.0140	0.0285	0.35	0.69
L	0.0350	0.0401	0.89	1.02
S	0.0830	0.1039	2.10	2.64
V	0.0177	0.0236	0.45	0.60

